



Schlage **Resolute**

SMART MORTICE LOCK

Quick Start Guide

Box contents

External lock body

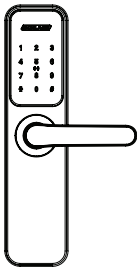

Internal lock body

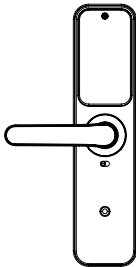

Gaskets

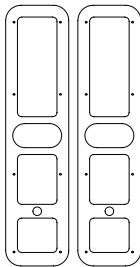

Keys and tags



Door thickness

- 35mm - 70mm

Tools required

- Tape measure
- Pencil
- Level
- Drill
- Drill bit - 10mm
- Hole saw - 20mm
- Screwdriver (Phillips)

Mortice lock included with kitsets

Fixing pack

Door thickness	Screw post	Screw	Spindle	Sliding screw	Mortice screw
35mm - 39mm	M5*30mm x 2	M5*25mm x 1 M5*50mm x 1	7.8*7.8*60mm x 1	M5*10mm x 1	Aluminium door: M5*10mm x 5 Wooden door: M4*20mm x 5
40mm - 60mm	M5*35mm x 2	M5*30mm x 1 M5*40mm x 1 M5*50mm x 1 M5*60mm x 1	7.8*7.8*80mm x 1		
61mm - 70mm	M5*35mm x 2	M5*50mm x 1 M5*70mm x 1	7.8*7.8*100mm x 1		

For more information visit schlage.co.nz/resolute

Exterior assembly

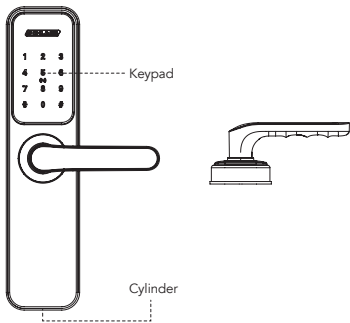

Interior assembly

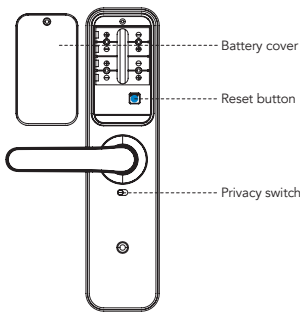

Installation

1. Prepare the door

- Follow the Schlage Resolute template to prepare your door.
- Mount lockbody into position.

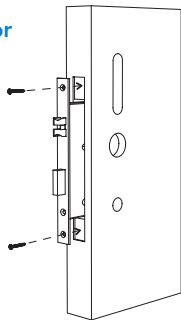

2. Fasten posts

- Attach the post to the lower stud on the back of the external unit.
- Attach the second post to the fixing post screw, slide the screw head into the slot on the top of the back of the external unit. Loosely tighten post to screw to allow free movement.

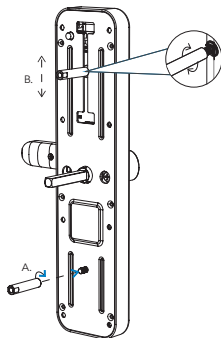

3. Handing (as required)

Remove lever retaining screw to loosen lever.

Rotate the lever 180°.

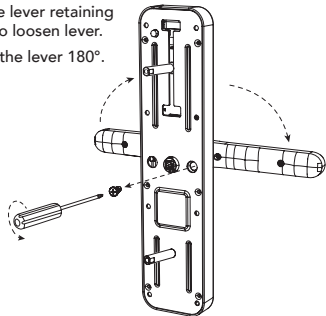

4. Handing (continued)

Tighten lever retaining screw to reattach the lever.

Repeat for internal unit.

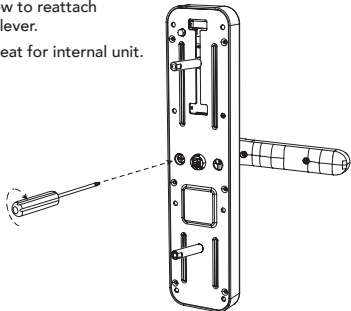

5. Adjust spindle holder direction

A. Attach spindle and secure with retaining clip.

B. Ensure the spindle holder arrow points downwards.

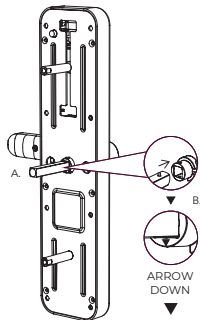

6. Attach gaskets

Attach and secure rubber gaskets to the internal and external units.

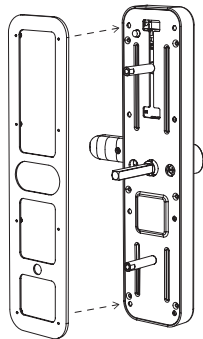

7. Position external unit to the door

Position the external unit to sit flush on the door, ensuring that the cable and spindle go through the fixing holes.

Adjust the top fixing post to align with the top fixing hole.

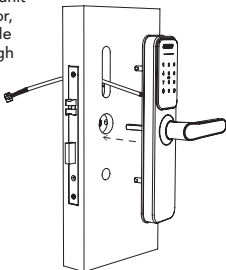

8. Position internal unit to the door

A. Remove battery cover from the internal unit.

B. Connect the cables ensuring excess cable is concealed inside the door.

C. Line up spindle to the spindle hole in the body of the unit.

D. Affix the internal and external units using the fixing screws.

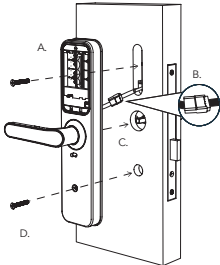

9. Install batteries

- Install 4x AA alkaline batteries.
- Secure the battery cover with screw.

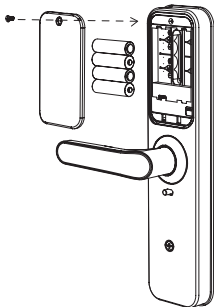

10. Test latch operation

With the door in the open position test lock operation:

- Rotate the external lever, ensure latch bolt does not retract (refer to step 5).
- Rotate the internal lever, ensure latch bolt does retract.

Test operation using code 123456# (ignore voice prompt during test).

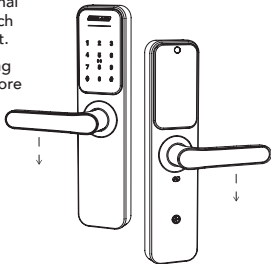

Pair and programme lock

IMPORTANT: Note for installer

Administrator code set up

Once the lock is installed on the door, the lock requires the default admin code to be changed. Refer to manual lock operation on page 8 to change the default admin code and set new PIN code/s.

Once PIN code/s are set, the lock voice command will no longer prompt for the lock to be paired to a mobile device.

IMPORTANT: Note for homeowner

Manual factory reset

If your lock was installed by someone other than yourself, we highly recommend you complete a factory reset on the lock to ensure all previously set PIN codes are successfully deleted.

1. Remove the battery cover and using a pointed object, press the reset button for 4 seconds (refer to page 2 for the location of the reset button).
2. The lock will prompt to enter a setup code. At this point enter 000# on the keypad.
3. The lock will prompt that the reset procedure is complete.
4. The lock is now available to be paired with a mobile device using the Schlage Breeze app.

Get mobile access with Schlage Breeze

For an enhanced experience and additional functionality, we recommend you download the Schlage Breeze mobile app from the Apple App Store or the Google Play Store.



Apple App Store



Google Play Store

1. Create a user account using your email address (or login if you have an existing account).
2. Ensure Bluetooth is enabled on your phone, tap the keypad of your Schlage Resolute lock to activate it.
3. To pair the lock with the app, click on the + and follow the instructions on the app.



Schlage Breeze app user functions

Within the Schlage Breeze app, users have access to more features than those available on the lock itself. This guide provides information on many of the features available.

Status of lock

Use the locked and unlocked icons to easily lock or unlock your door, or simply to check the status of the lock (locked or unlocked).

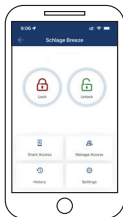

PIN codes

The Schlage Resolute allows you to store up to 150 PIN codes - either custom, permanent, recurring or scheduled.

Default master PIN code is 123456#

Master PIN codes must contain 6-11 digits

Custom created codes can contain 4-9 digits

To add a new PIN code, use the Grant Access icon, add PIN code. For a customised PIN code, use the custom feature, add your guest's name, and set your PIN code.

To manage your PIN codes, select Manage Access and update or delete user access as required.

Virtual keys

When you regularly need to share access to many guests, you can message them PIN code access.

This is a great solution for home share properties. Select Grant Access, Invite Breeze User and enter the details for your guest. You can share this virtual key by various options including email or text message.

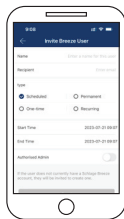

Key tags

The Schlage Resolute allows you to store up to 200 key tag credentials. Three key tags are provided with your Schlage Resolute lock, additional key tags can be purchased through your local door hardware retailer.

To set up your key tags, select Grant Access, Add Credential, ensure you name your key tag and complete set up of your credential.



To manage your credentials, select Manage Access and update or delete user access as required.

Auto locking

The Schlage Resolute lock default is set with a 5 second auto lock, this can be changed in the Settings, Auto Lock function by selecting a different time delay.

Passage mode

The lock can be switched to passage mode in the Schlage Breeze app within the Settings function. In this mode, the internal and external lever is unlocked, and you may enter freely. You can either set specific days/times to operate passage mode or disable this feature.

When passage mode is in operation, you may still lock the unit externally by holding the # key for 3 seconds. It will resume passage mode when unlocked via PIN, key tag or key override until the passage mode period completes or the feature is disabled via the Schlage Breeze app.



Clock

After installation of your lock and registering for the Schlage Breeze app, the clock is automatically set to your local time. The lock has a feature within the Settings function to change to daylight savings, if you use the scheduled PIN code feature, ensure you change to current daylight savings time to ensure the correct time is used by the lock.

Lock notifications history

To view the audit trail of when the lock was used and by which user, select History. This provides information on your users, timing, or any attempts of adding incorrect PIN codes.

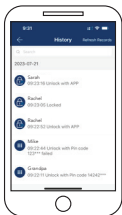

Resetting your lock

We recommend you reset your lock for greater security if you have recently purchased a home and there may have been other users of your lock. Your lock can be reset either in the Schlage Breeze app or on the Schlage Resolute lock.

Within the Schlage Breeze app:

1. Select Settings, then scroll to the bottom and select the Delete button.
2. Enter your account password – this is the password you used when you registered the Schlage Breeze app.
3. The Delete button, resets the lock and unpairs the Schlage Breeze app, so that it can be repaired with another mobile phone.

To manually reset your lock refer to page 5.

Lock sound

To enable or disable the lock sound select Settings, Lock Sound.

Note, by disabling the sound, both the lock voice prompts and beeps will be disabled.

Manual lock operation

Follow this simple chart if you are manually programming your lock.

Further lock functions are available using the Schlage Breeze app, refer to pages 5-7 for more information.

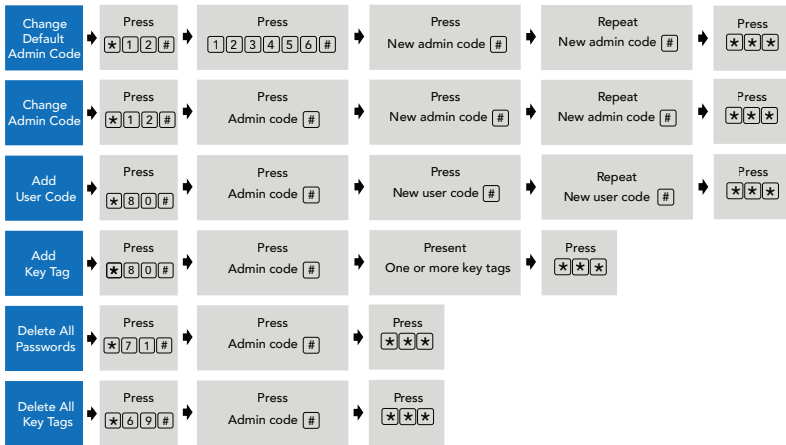

Hardware specifications

Item	Specifications	Notes
External and internal assemblies	303mm (L) x 73mm (W) x 28mm (D)	Operation temperature: -30°C to 55°C
Battery	AA alkaline battery x 4 (Operation voltage: 4.8 to 6V)	Lasts 6-12 months depending on usage

Schlage Resolute lock functions

Refer to the manual lock operation on page 8 for further instructions on manually programming your lock.

Tips

- To activate and illuminate the keypad, press the # key.
- Always enter the # key after entering your PIN code.

Deadbolt operation

For additional security when locking your Schlage Resolute lock, rotate the lever upwards to operate the deadbolt.

Upon re-entry, enter your PIN code followed by the hash, rotate the lever downwards to retract the deadbolt and latch and unlock your door.

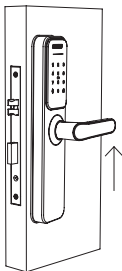

Random PIN code

This security feature allows a user to randomly enter digits before and/or after the PIN code to prevent the user PIN code from being exposed.

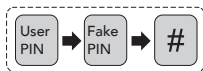
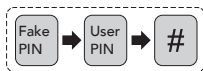

Tamper alert

The Schlage Resolute lock allows for four attempts to correctly input your code, on the fifth incorrect entry the lock alarm will sound. The alarm sounds for 30 seconds, during this time you cannot continue to enter PIN codes. You can however unlock the lock through the Schlage Breeze app which will also turn the lock alarm sound off.

Low battery notification

The keypad flashes to notify you when the battery is low, with a voice prompt saying, 'Battery low please replace'. Also, while in the Schlage Breeze app, the app will display a low battery notification.

Warranty conditions

The Schlage Resolute provides a 2 year mechanical and electronic warranty.

Our goods come with guarantees that cannot be excluded under the local consumer law. You are entitled to have the goods repaired or replaced if the goods fail to be of acceptable quality and the failure does not amount to a major failure. The warranty does not cover any defect or damage which may be caused or partly caused if the goods are not properly maintained, installed or are not suitable to the specified application.

Refer to our website for our finish warranty www.allegion.co.nz/finisheswarranty.

Factory default settings

Settings	Factory default
Master PIN code	123456
Beeper	Enabled
Wrong code entry limit	5 times
Bluetooth mode	Enabled

Refer to page 5 or 7 for instructions on how to complete a factory reset if required.

Schlage Wi-Fi Bridge (BZ100)

Empower your Schlage Resolute smart mortice lock with Wi-Fi capability. The Schlage Wi-Fi Bridge (BZ100) pairs to your Schlage Resolute smart mortice lock, to provide you with a real-time connection through your smartphone.

Ask your retailer about the Schlage Wi-Fi Bridge (BZ100), sold separately.



Care and maintenance

Door furniture

At six (6) monthly intervals, the fixing screws securing the furniture to the door, both surface fix and through fix, should be checked and tightened as required. Loose fitting furniture which fails will not be covered under warranty.

All door furniture should only be wiped clean with a soft damp cloth. A non-abrasive mild household detergent may be used to remove ingrained grime.

Mortice lock

Care should be taken to ensure the internal components are kept free of dirt and filings during installation as this is the most common cause of malfunction and will not be covered under warranty.



For more information visit
schlage.co.nz/resolute

Australia
1800 098 094
info.au@allegion.com
www.allegion.com.au

New Zealand
0800 477 869
nzinfo@allegion.com
www.allegion.co.nz

© 2023 Allegion

